

# eIVP1300

Intel Atom E3845 / E3825 Mobile Network Video Recorder with 4-Channel IP Cameras

---

*User's Manual*



Copyright © EverFocus Electronics Corp.  
Release Date: September 2019

EVERFOCUS ELECTRONICS CORPORATION

## eIVP1300

# Intel Atom E3845 / E3825 Mobile Network Video Recorder with 4-Channel IP Cameras

## User's Manual

---

© 1995-2019 EverFocus Electronics Corp.  
[www.everfocus.com.tw](http://www.everfocus.com.tw)

### **Disclaimer**

All the images including product pictures or screen shots in this document are for example only. The images may vary depending on the product and software version. Information contained in this document is subject to change without notice.

### **Copyright**

All rights reserved. No part of the contents of this manual may be reproduced or transmitted in any form or by any means without written permission of the EverFocus Electronics Corporation.

- Microsoft Windows is a registered trademark of Microsoft Corp.
- Intel, Pentium, Celeron, and Xeon are registered trademarks of Intel Corporation
- Core, Atom are trademarks of Intel Corporation
- ITE is a trademark of Integrated Technology Express, Inc.
- IBM, PC/AT, PS/2, and VGA are trademarks of International Business Machines Corporation.

All other product names or trademarks are properties of their respective owners.

# Safety Precautions

Please read the following safety instructions carefully. It is advised that you keep this manual for future references.

- All cautions and warnings on the device should be noted.
- All cables and adapters supplied by EverFocus are certified and in accordance with the material safety laws and regulations of the country of sale. Do not use any cables or adapters not supplied by EverFocus to prevent system malfunction or fires.
- Make sure the power source matches the power rating of the device.
- Position the power cord so that people cannot step on it. Do not place anything over the power cord.
- Always completely disconnect the power before working on the system's hardware.
- No connections should be made when the system is powered as a sudden rush of power may damage sensitive electronic components.
- If the device is not to be used for a long time, disconnect it from the power supply to avoid damage by transient over-voltage.
- Always disconnect this device from any AC supply before cleaning.
- While cleaning, use a damp cloth instead of liquid or spray detergents.
- Make sure the device is installed near a power outlet and is easily accessible.
- Keep this device away from humidity.
- Place the device on a solid surface during installation to prevent falls.
- Do not cover the openings on the device to ensure optimal heat dissipation.
- Watch out for high temperatures when the system is running.
- Do not touch the heat sink or heat spreader when the system is running.
- Never pour any liquid into the openings. This could cause fire or electric shock.
- As most electronic components are sensitive to static electrical charge, be sure to ground yourself to prevent static charge when installing the internal components. Use a grounding wrist strap and contain all electronic components in any static-shielded containers.
- If any of the following situations arises, please contact our service personnel (ts@everfocus.com.tw):
  - Damaged power cord or plug
  - Liquid intrusion to the device
  - Exposure to moisture
  - Device is not working as expected or in a manner as described in this manual
  - The device is dropped or damaged
  - Any obvious signs of damage displayed on the device
- **DO NOT LEAVE THIS DEVICE IN AN UNCONTROLLED ENVIRONMENT WITH TEMPERATURES BEYOND THE DEVICE'S PERMITTED STORAGE TEMPERATURES (SEE SPECIFICATION) TO PREVENT DAMAGE.**

## FCC Statement

**Warning!**



This device complies with Part 15 FCC Rules. Operation is subject to the following two conditions: (1) this device may not cause harmful interference, and (2) this device must accept any interference received including interference that may cause undesired operation.

**Caution:**

There is a danger of explosion if the battery is incorrectly replaced. Replace only with the same or equivalent type recommended by the manufacturer. Dispose of used batteries according to the manufacturer's instructions and your local government's recycling or disposal directives.

**Attention:**

Il y a un risque d'explosion si la batterie est remplacée de façon incorrecte.

Ne la remplacer qu'avec le même modèle ou équivalent recommandé par le constructeur. Recycler les batteries usées en accord avec les instructions du fabricant et les directives gouvernementales de recyclage.

## RoHS Requirements

設備名稱 (Equipment): 網路數位錄放影機 · 型號 ( 型式 ) / Type designation (Type): eIVP1300						
單元 Unit	限用物質及其化學符號 Restricted substances and its chemical symbols					
	鉛Lead (Pb)	汞Mercury (Hg)	鎘Cadmium (Cd)	六價鉻 Hexavalent chromium (Cr+6)	多溴聯苯 Polybrominated biphenyls (PBB)	多溴二苯醚 Polybrominated diphenyl ethers (PBDE)
印刷電路板及 電子零組件 PCB & Other Components	X	○	○	○	○	○
外部訊號連接 器及線材 Wires & Connectors for External Connections	X	○	○	○	○	○
<p>○：表示該有毒物質在該部件所有均質材料中的含量均在SJ/T 11363-2006標準規定的限量要求以下。 The quantity of poisonous or hazardous substances or elements found in each of the component's parts is below the SJ/T 11363-2006-stipulated requirement.</p> <p>X：表示該有毒物質至少在該部件的某一均質材料中的含量超出 SJ/T 11363-2006標準規定的限量要求。 The quantity of poisonous or hazardous substances or elements found in at least one of the component's parts is beyond the SJ/T 11363-2006-stipulated requirement.</p> <p>備註：一、此產品所標示之環保使用期限，係指在一般正常使用狀況下。The Environment Friendly Use Period as labeled on this product is applicable under normal usage only</p>						

# TABLE OF CONTENTS

1.	Introduction .....	1
1.1	Features .....	1
1.2	Dimensions.....	2
1.3	Packing List.....	2
1.4	Front Panel.....	3
1.5	Rear Panel .....	4
2.	Connection and Installation.....	5
2.1	Storage Installation .....	5
2.1.1	Storage Compatibility List .....	6
2.2	DC Out Cable .....	7
3.	AMI BIOS Setup.....	8
3.1	System Test and Initialization .....	8
3.2	AMI BIOS Setup.....	9
3.3	Setup Submenu: Main .....	9
3.4	Setup Submenu: Advanced.....	10
3.4.1	Advanced: Power Management .....	10
3.4.1.1	Power Management: S5 RTC Wake Settings .....	12
3.4.2	Advanced: Super IO Configuration .....	13
3.4.2.1	Super IO Configuration: Serial Port 1 Configuration .....	13
3.4.2.2	Super IO Configuration: Serial Port 2 Configuration .....	14
3.4.2.3	Super IO Configuration: Serial Port 3 Configuration .....	14
3.4.2.4	Super IO Configuration: Serial Port 4 Configuration .....	15
3.4.2.5	Super IO Configuration: Smart Fan Function.....	17
3.4.2.6	Super IO Configuration: Smart Fan Mode Configuration .....	17
3.4.3	Advanced: Digital IO.....	18
3.4.4	Advanced: H/W Monitor.....	19
3.4.5	Advanced: CPU Configuration.....	19
3.4.5.1	CPU Configuration: Socket 0 CPU Information.....	20
3.4.6	Advanced: IDE Configuration .....	20
3.4.7	Advanced: CSM Configuration .....	21
3.4.8	Advanced: Trusted Computing .....	22
3.4.9	Advanced: USB Configuration.....	23
3.4.10	Advanced: Touch Device.....	24
3.5	Setup Submenu: Chipset.....	24
3.5.1	Chipset: Host Bridge.....	25
3.5.1.1	CPU Configuration: Socket 0 CPU Information .....	26
3.5.2	Chipset: South Bridge.....	27
3.5.2.1	South Bridge: Azalia HD Audio.....	28
3.5.2.2	South Bridge: USB Configuration .....	29
3.5.2.3	South Bridge: PCI Express Configuration .....	30
3.6	Setup Submenu: Security.....	31
3.7	Setup Submenu: Boot .....	32
3.8	Setup submenu: Exit .....	33
4.	Specification.....	34

# Chapter 1

## 1. Introduction

The eIVP1300 is one of EverFocus' eIVP series AI mobile NVRs adopting Intel® Atom™ processor and Movidius™ Myriad™ X AI core module. The model supports 4 IP cameras, wide operating temperature ranging from 0°C to 60°C, and wide DC range of DC 9-24V. The eIVP1300 is complied with the MIL-STD-810G standard for the utmost viability for vehicular use. Besides, the model is also CE, FCC and RoHS certified. The eIVP1300 AI mobile NVR carries everything you need for computing on the road.

### eIVP1300 Model SKU:

CPU	Memory	Display	Storage	LAN	USB	RS232/48	Power
<b>Atom E3845</b>	Onboard DDR3L (4GB)	HDMI x 1, VGA x 1	optional	GbE x 2	USB3.0 x 1 USB2.0 x 3	RS232 x 2	9~24VDC
<b>Atom E3825</b>	Onboard DDR3L (4GB)	HDMI x 1, VGA x 1	optional	GbE x 2	USB3.0 x 1 USB2.0 x 3	RS232 x 2	9~24VDC

### 1.1 Features

- In-vehicle network video recorder platform
- Intel® Atom™ E3845 / E3825 processor
- Onboard DDR3L memory up to 4GB
- Intel® Integrated Graphics Engine supports 2 display outputs by HDMI x 1, VGA x 1
- Intel® I211 (or 210) Ethernet x 2 ports (GbE x 2)
- Supports 4-channel IP cameras
- Supports removable SSD storage (optional)
- Supports 8-bit digital I/O (optional), USB2.0 x 3, USB3.0 x 1
- Supports RS-232 x 2
- Intel® Movidius™ Myriad™ X AI core module (optional)
- Supports CAN Bus 2.0B (optional)
- Wide DC range DC 9-24V
- CE, FCC, RoHS certified

## 1.2 Dimensions

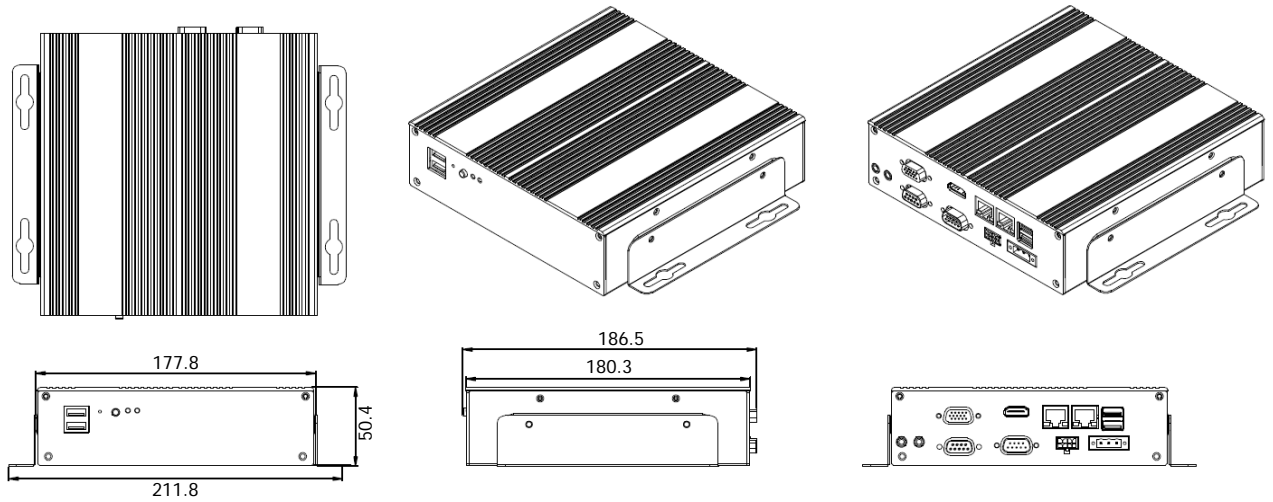

Unit: mm

## 1.3 Packing List

- |   |   |
|---|---|
| <ul style="list-style-type: none"> <li>• NVR x 1</li> <li>• DC Power Terminal Block d x 1</li> <li>• DC Out Cable x 1 (power supply for cameras)</li> </ul> | <ul style="list-style-type: none"> <li>• mSATA Screw x 1</li> <li>• 2.5" SSD Screw x 4</li> <li>• User Manual x 1</li> <li>• CD x 1 (see Note 3)</li> </ul> |
|---|---|

### Note:

1. Equipment configurations and supplied accessories vary by country. Please consult your local EverFocus office or agents for more information. Please also keep the shipping carton for possible future use.
2. Contact the shipper if any items appear to have been damaged in the shipping process.
3. The CD contains the User Manual and some Drivers for the system. If you can't find the required drivers from the CD, please go to our website for related drivers. [www.everfocus.com.tw](http://www.everfocus.com.tw)



## 1.4 Front Panel

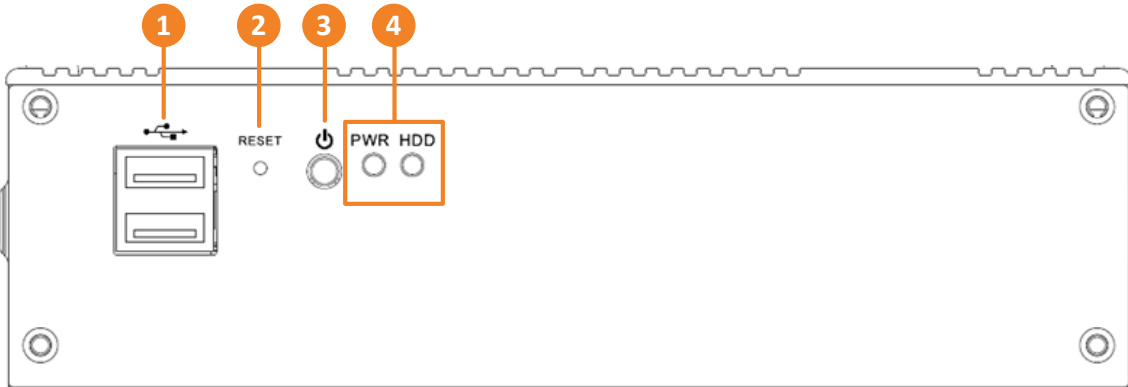

No.	Name	Description
1	<b>USB2.0 Ports</b>	USB2.0 ports.
2	<b>Reset</b>	Press the button to restart the system.
3	<b>Power Button</b>	Press the button to turn on or turn off the system.
4	<b>LED Indicator</b>	<b>Power:</b> When power is on, the LED will continue lighting in red. <b>HDD:</b> When storage is reading/writing data, the LED will flashes green.

### 1.5 Rear Panel

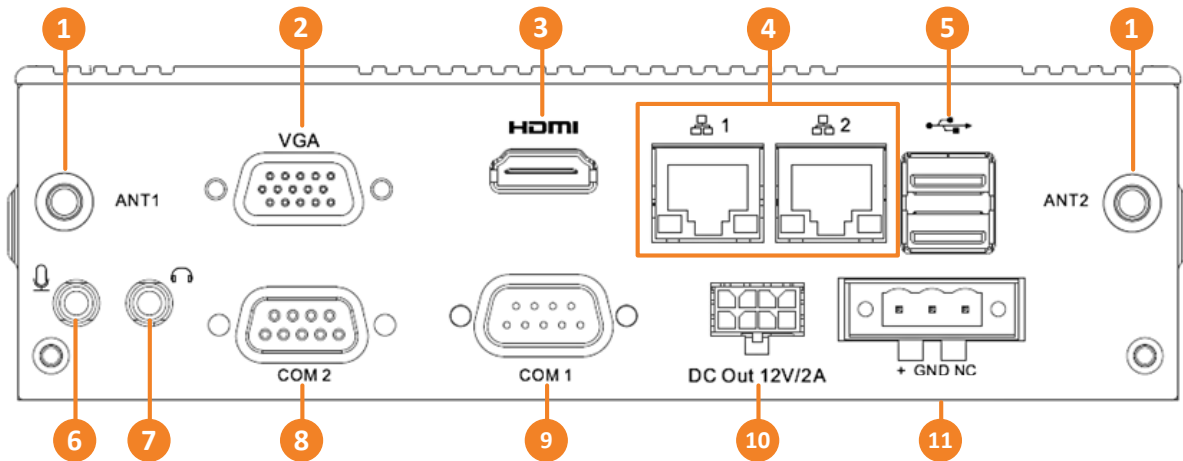

No.	Name	Description
1	<b>Antenna</b>	Connects the antenna to the mobile NVR for 3G / 4G / WiFi functions.
2	<b>VGA Port</b>	VGA display output.
3	<b>HDMI Port</b>	HDMI display output.
4	<b>WAN/LAN</b>	Connects to the Network.
5	<b>USB2.0 Port USB3.0 Port</b>	USB ports.
6	<b>Audio Input</b>	Connects to audio input devices, such as microphones. Note that the microphones with a (built-in) amplifier and external power supply are required.
7	<b>Audio Output</b>	Connects to an audio output device, such as speakers. Note that the speakers with a (built-in) amplifier and external power supply are required.
8	<b>COM2</b>	RS-232 port.
9	<b>COM1</b>	RS-232 port.
10	<b>Power Output</b>	A total of 12VDC, 2A power supply to the connected cameras. Please refer to <i>2.2 DC Power Out Cable</i> .
11	<b>Power Input</b>	Insert the supplied <b>DC Power Terminal Block</b> and then connect the system to a DC 9-24V power source.

# Chapter 2

## 2. Connection and Installation

### 2.1 Storage Installation

The eIVP1300 supports mSATA drive (half size) and 2.5" SSD for storage. You can install either one for storage.

**To install the mSATA (half size) drive:**

1. Make sure the NVR is power-off.
2. Unscrew the four screws on the rear panel and then remove the cover from the housing.



3. Find the **mSATA Interface** on the motherboard and then screw your mSATA (half size) drive to the mSATA Interface using the supplied **mSATA Screw**.

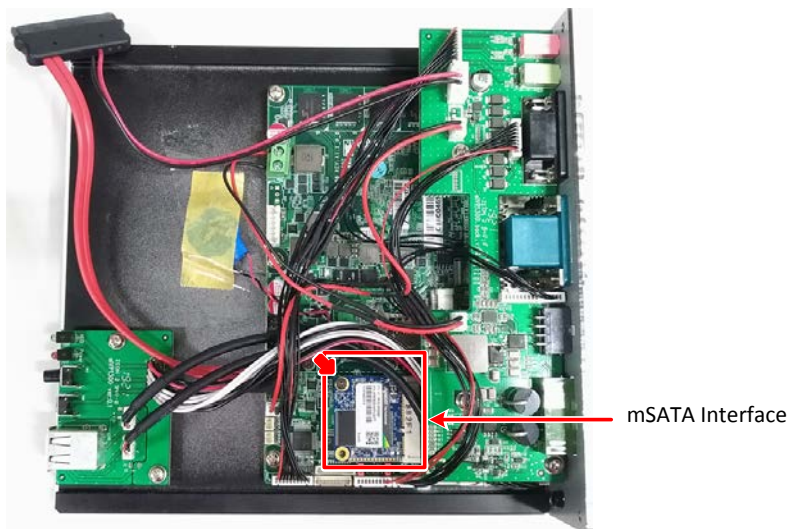

**To install a 2.5" SSD:**

1. Make sure the NVR is power-off.
2. Unscrew the four screws on the rear panel and then remove the cover from the housing.



3. Screw the SSD to the lower housing cover using the supplied **SSD Screws**. Find the SATA cable inside the NVR, and connect the SATA cable to the SATA port on the SSD.

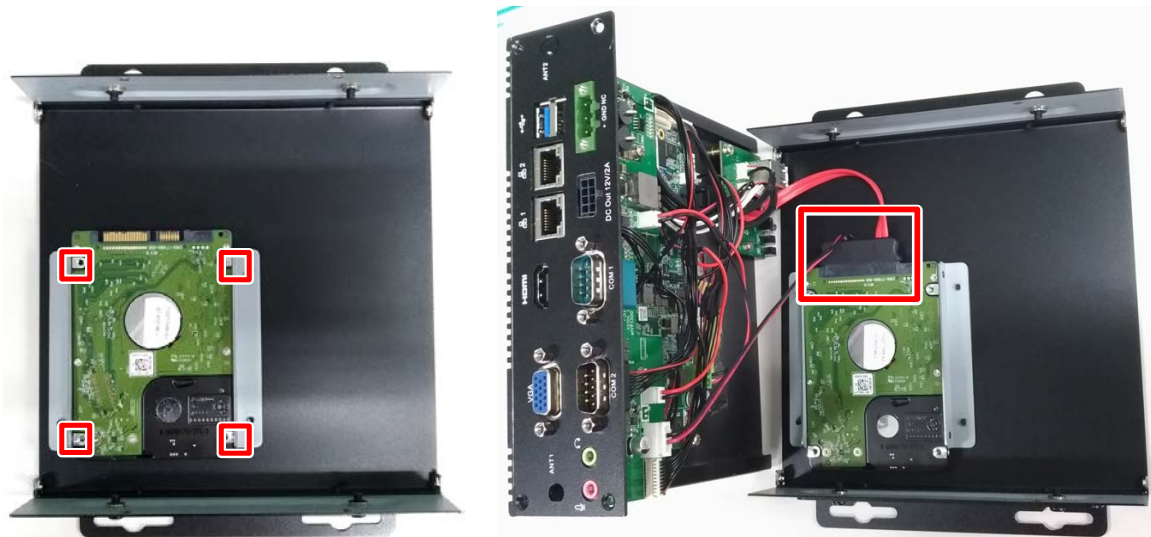

4. Screw the housing cover back to the NVR.

**2.1.1 Storage Compatibility List**

Please go to the product page (Download) on EverFocus' Website [www.everfocus.com.tw](http://www.everfocus.com.tw) to see the latest Storage Compatibility List. It's recommended to use the storage models listed on the Storage Compatibility List to ensure your storage devices are compatible.

## 2.2 DC Out Cable

The eIVP1300 provides a total of 12V/2A DC output with four sets of power output wires (+/-) for the connected IP cameras.

Connect the supplied **DC Out Cable** to the **DC Out** port on the rear panel of the NVR.

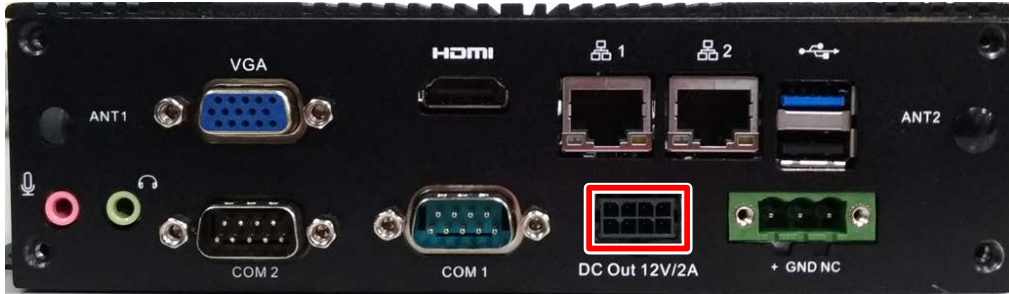

- (black)

+ (black with white stripe)

# Chapter 3

## 3. AMI BIOS Setup

### 3.1 System Test and Initialization

The board uses certain routines to perform testing and initialization. If an error, fatal or non-fatal, is encountered, a few short beeps or an error message will be outputted. The board can usually continue the boot up sequence with non-fatal errors.

The system configuration verification routines check the current system configuration against the values stored in the CMOS memory. If they do not match, an error message will be outputted, in which case you will need to run the BIOS setup program to set the configuration information in memory.

There are three situations in which you will need to change the CMOS settings:

- You are starting your system for the first time
- You have changed your system's hardware
- The CMOS memory has lost power and the configuration information is erased

The system's CMOS memory uses a backup battery for data retention, which is to be replaced once emptied.

### 3.2 AMI BIOS Setup

The AMI BIOS ROM has a pre-installed Setup program that allows users to modify basic system configurations, which is stored in the battery-backed CMOS RAM and BIOS NVRAM so that the information is retained when the power is turned off.

To enter BIOS Setup, press <Del> or <F2> immediately while your computer is powering up.

The function for each interface can be found below.

- Main – Date and time can be set here. Press <Tab> to switch between date elements
- Advanced – Enable/ Disable boot option for legacy network devices
- Chipset – For hosting bridge parameters
- Boot – Enable/ Disable quiet Boot Option
- Security – The setup administrator password can be set here
- Save & Exit – Save your changes and exit the program

### 3.3 Setup Submenu: Main

Press the “Delete” key to enter the setup page.

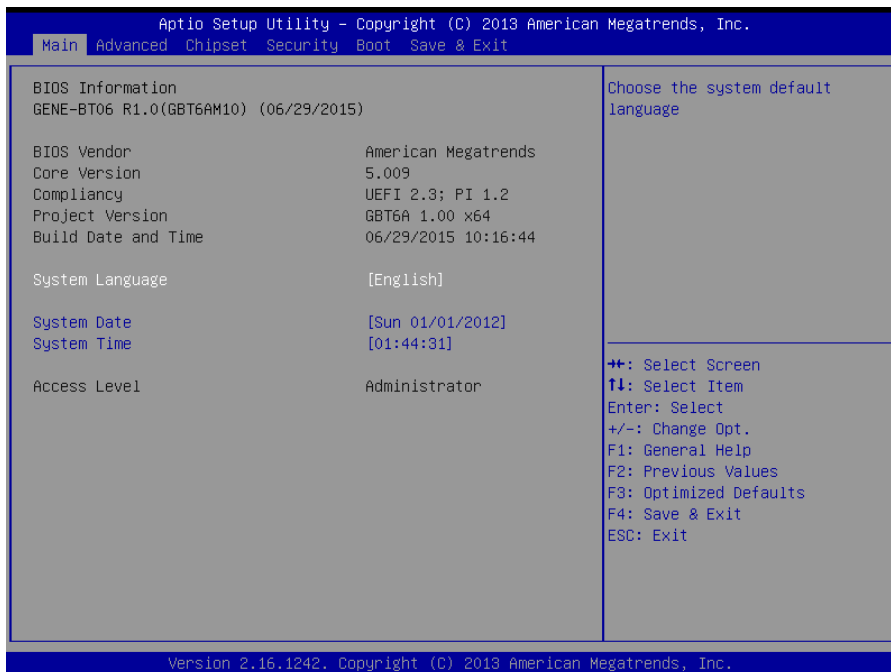

### 3.4 Setup Submenu: Advanced

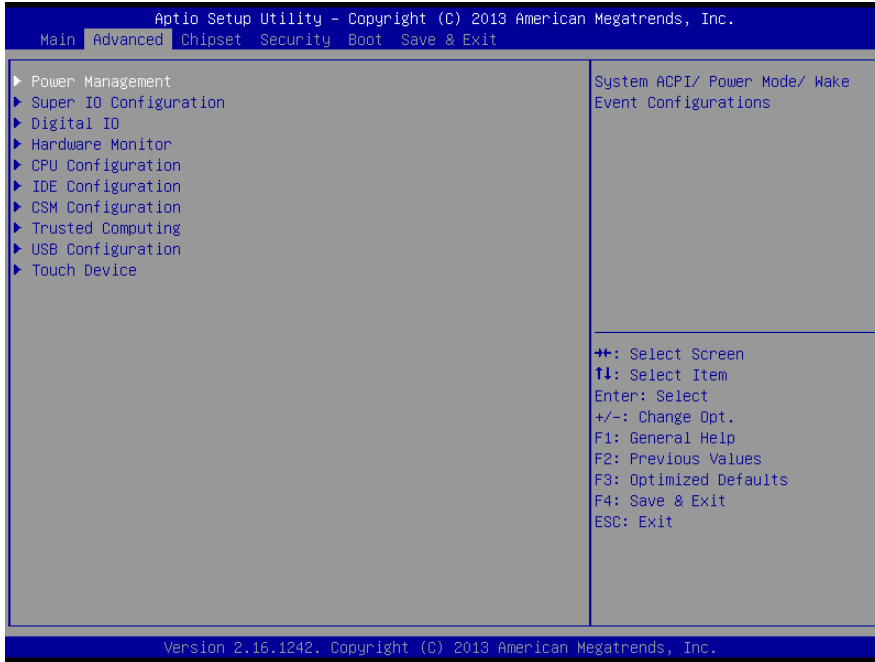

#### 3.4.1 Advanced: Power Management

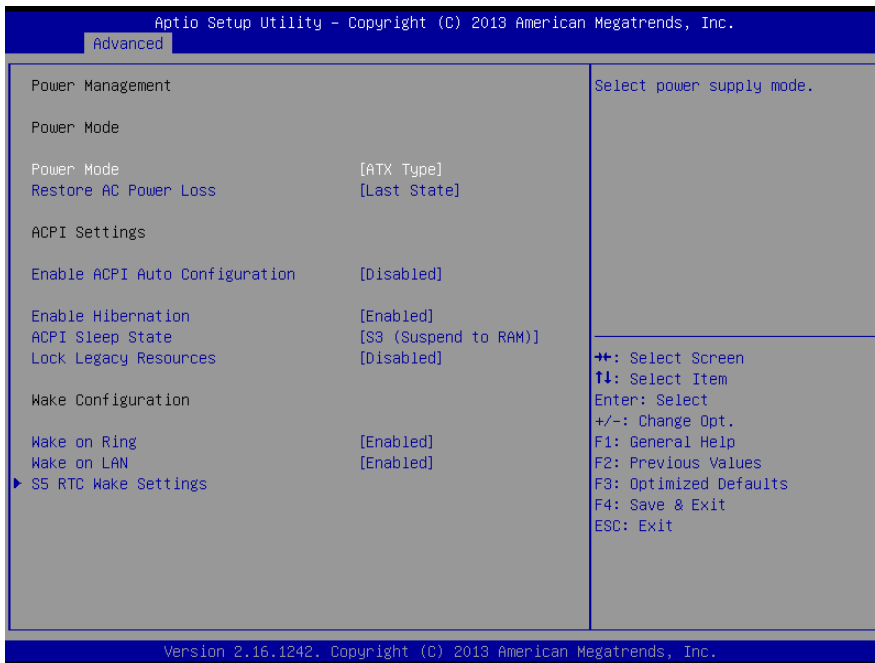



Options summary:

Power Mode	ATX Type	Optimal Default, Failsafe Default
	AT Type	
Select power supply mode		
Restore AC Power Loss	Power Off	Optimal Default, Failsafe Default
	Power On	
	Last State	
Select AC power state when power is re-applied after a power failure		
Enable ACPI Auto Configuration	Enable	Optimal Default, Failsafe Default
	Disable	
Enables or Disables BIOS ACPI Auto Configuration		
Enable Hibernation	Enable	Optimal Default, Failsafe Default
	Disable	
Enables or Disables System ability to Hibernation (OS/S4 Sleep State). This option may be not effective with some OS		
ACPI Sleep State	Suspend Disabled	Optimal Default, Failsafe Default
	S3 only(Suspend to RAM)	
Select highest ACPI sleep state the System will enter when the Suspend button is pressed		
Lock Legacy Resources	Enable	Optimal Default, Failsafe Default
	Disable	
Enables or Disables Lock of Legacy Resources		
Wake on Ring	Enable	Optimal Default, Failsafe Default
	Disable	
Enabled/Disabled wake from Ring		
Wake on LAN	Enable	Optimal Default, Failsafe Default
	Disable	
Enabled/Disabled wake from LAN		
S5 RTC Wake Settings		
Enable system to wake from S5 using RTC alarm.		

### 3.4.1.1 Power Management: S5 RTC Wake Settings

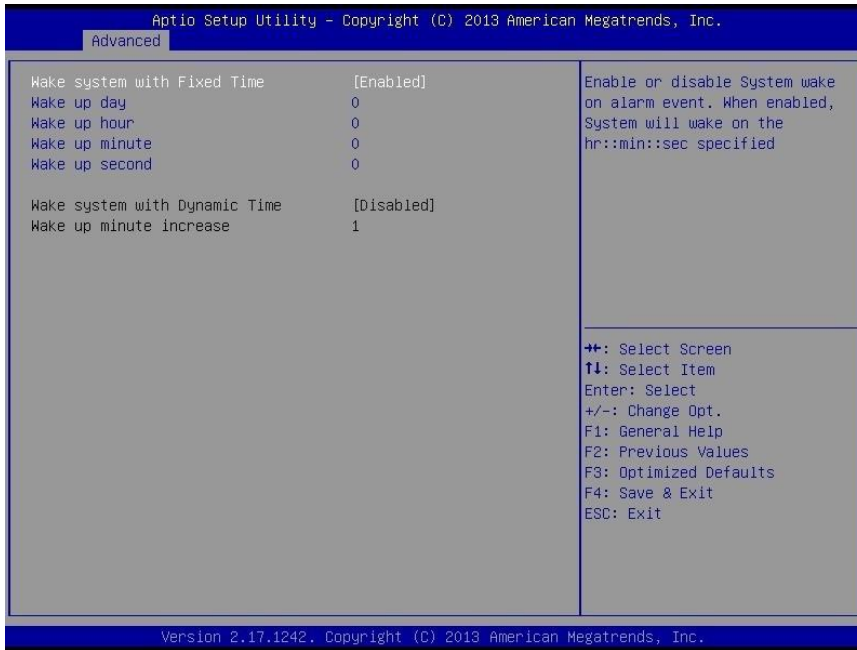

Options summary:

Wake system with Fixed Time	Enable	Optimal Default, Failsafe Default
	Disable	
Enable or disable System wake on alarm event. Wake up time is setting by following settings.		
Wake up day	0-31	
Select 0 for daily system wake up 1-31 for which day of the month that you would like the system to wake up		
Wake up hour	0-23	
Wake up minute	0-59	
Wake up second	0-59	
Wake system with Dynamic Time	Enable	Optimal Default, Failsafe Default
	Disable	
Enable or disable System wake on alarm event. Wake up time is current time + Increase minutes.		
Wake up minute increase	1-15	

### 3.4.2 Advanced: Super IO Configuration

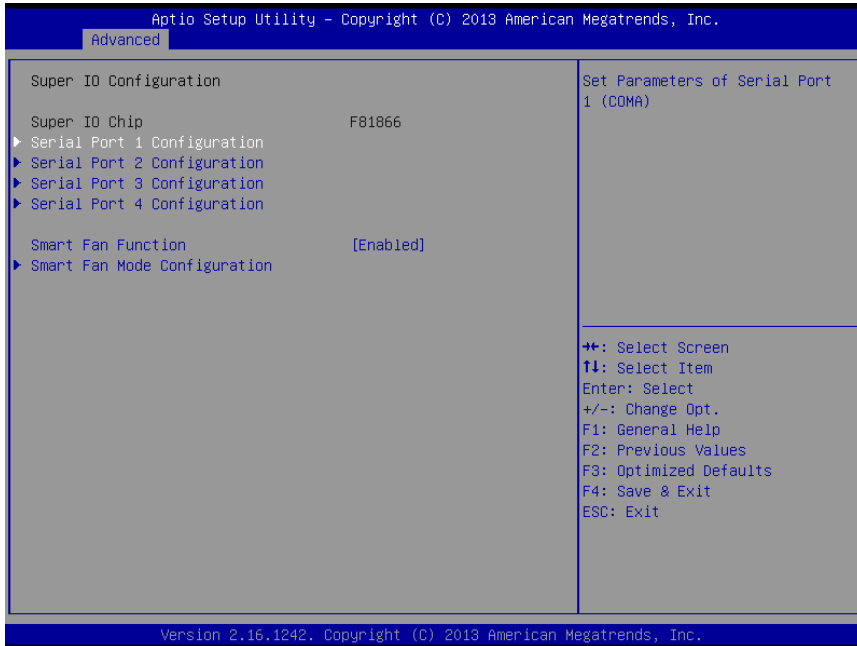

#### 3.4.2.1 Super IO Configuration: Serial Port 1 Configuration

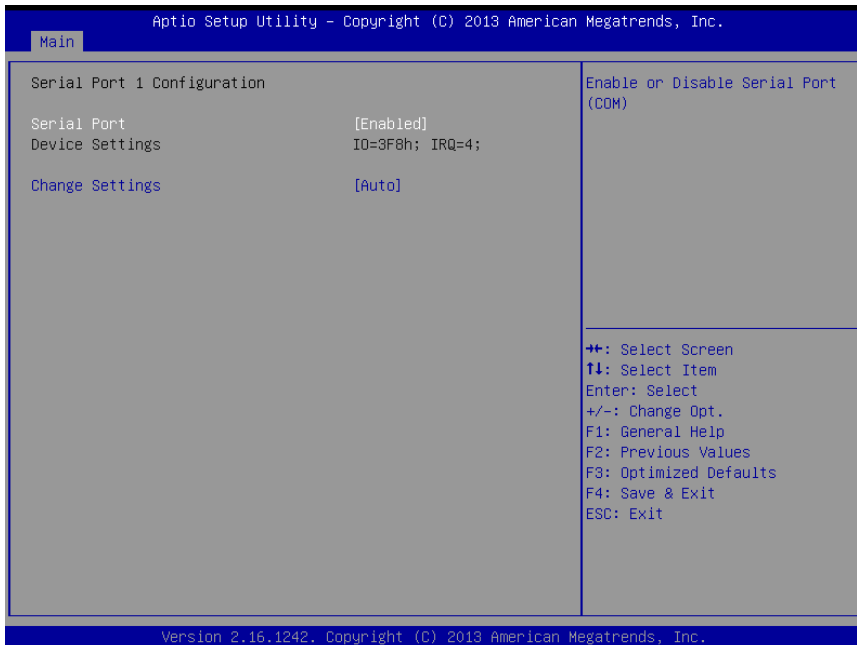

### 3.4.2.2 Super IO Configuration: Serial Port 2 Configuration

Aptio Setup Utility - Copyright (C) 2013 American Megatrends, Inc.

Main

Serial Port 2 Configuration		Enable or Disable Serial Port (COM)
Serial Port	[Enabled]	
Device Settings	ID=2F6h; IRQ=3;	
Change Settings	[Auto]	
Working model	[RS232]	

++: Select Screen  
 ↑↓: Select Item  
 Enter: Select  
 +/-: Change Opt.  
 F1: General Help  
 F2: Previous Values  
 F3: Optimized Defaults  
 F4: Save & Exit  
 ESC: Exit

Version 2.16.1242. Copyright (C) 2013 American Megatrends, Inc.

### 3.4.2.3 Super IO Configuration: Serial Port 3 Configuration

Aptio Setup Utility - Copyright (C) 2013 American Megatrends, Inc.

Main

Serial Port 3 Configuration		Enable or Disable Serial Port (COM)
Serial Port	[Enabled]	
Device Settings	ID=3E8h; IRQ=10;	
Change Settings	[Auto]	
Working model	[RS232]	

++: Select Screen  
 ↑↓: Select Item  
 Enter: Select  
 +/-: Change Opt.  
 F1: General Help  
 F2: Previous Values  
 F3: Optimized Defaults  
 F4: Save & Exit  
 ESC: Exit

Version 2.16.1242. Copyright (C) 2013 American Megatrends, Inc.

### 3.4.2.4 Super IO Configuration: Serial Port 4 Configuration

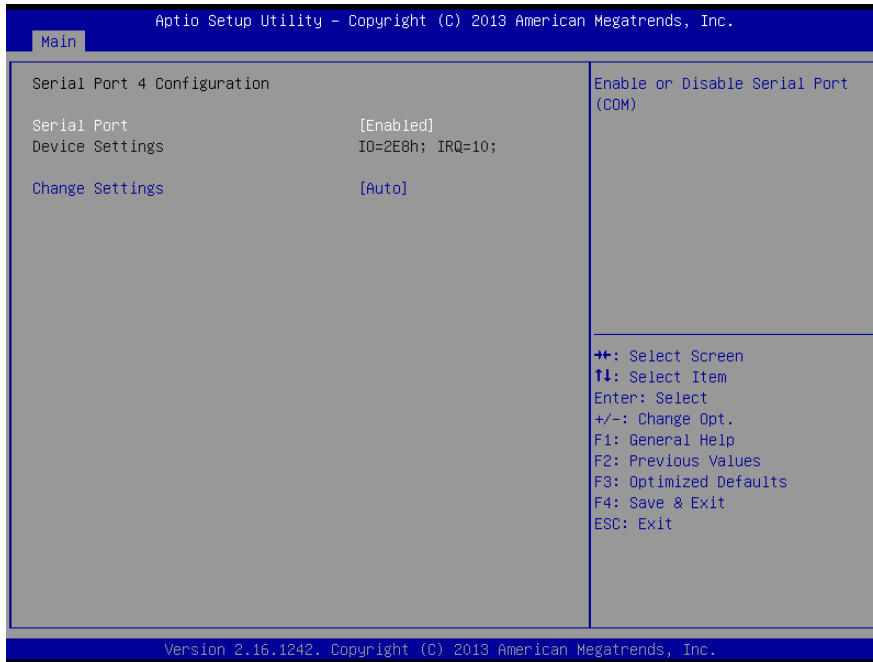

Options summary:

Serial Port	Disabled	
	Enabled	Default
Allows BIOS to En/Disable correspond serial port.		
Change Settings (Serial Port 1)	Auto	Default
	IO=3F8h; IRQ=4;	
	IO=3F8h; IRQ=3,4,5,6,7,9,10,11,12;	
	IO=2F8h; IRQ=3,4,5,6,7,9,10,11,12;	
	IO=3E8h; IRQ=3,4,5,6,7,9,10,11,12;	
	IO=2E8h; IRQ=3,4,5,6,7,9,10,11,12;	
Allows BIOS to Select Serial Port resource.		
Change Settings (Serial Port 2)	Auto	Default
	IO=2F8h; IRQ=3;	
	IO=3F8h; IRQ=3,4,5,6,7,9,10,11,12;	

	IO=2F8h; IRQ=3,4,5,6,7,9,10,11,12;	
	IO=3E8h; IRQ=3,4,5,6,7,9,10,11,12;	
	IO=2E8h; IRQ=3,4,5,6,7,9,10,11,12;	
Working model	RS232	Default
	RS422	
	RS485	
Select Working model		
Change Settings (Serial Port 3)	Auto	Default
	IO=3E8h; IRQ=7;	
	IO=3F8h; IRQ=3,4,5,6,7,9,10,11,12;	
	IO=2F8h; IRQ=3,4,5,6,7,9,10,11,12;	
	IO=3E8h; IRQ=3,4,5,6,7,9,10,11,12;	
	IO=2E8h; IRQ=3,4,5,6,7,9,10,11,12;	
	IO=2F0h; IRQ=3,4,5,6,7,9,10,11,12;	
	IO=2E0h; IRQ=3,4,5,6,7,9,10,11,12;	
Working model	RS232	Default
	RS422	
	RS485	
Select Working model		
Change Settings (Serial Port 4)	Auto	Default
	IO=2E8h; IRQ=7;	
	IO=3F8h; IRQ=3,4,5,6,7,9,10,11,12;	
	IO=2F8h; IRQ=3,4,5,6,7,9,10,11,12;	
	IO=3E8h; IRQ=3,4,5,6,7,9,10,11,12;	
	IO=2E8h; IRQ=3,4,5,6,7,9,10,11,12;	

IO=2E8h; IRQ=3,4,5,6,7,9,10,11,12;	
IO=2F0h; IRQ=3,4,5,6,7,9,10,11,12;	
IO=2E0h; IRQ=3,4,5,6,7,9,10,11,12;	

### 3.4.2.5 Super IO Configuration: Smart Fan Function

Options summary:

Smart Fan Function	Disabled	Optimal Default, Failsafe Default
	Enabled	
Enabled or Disabled Smart Fan		

### 3.4.2.6 Super IO Configuration: Smart Fan Mode Configuration

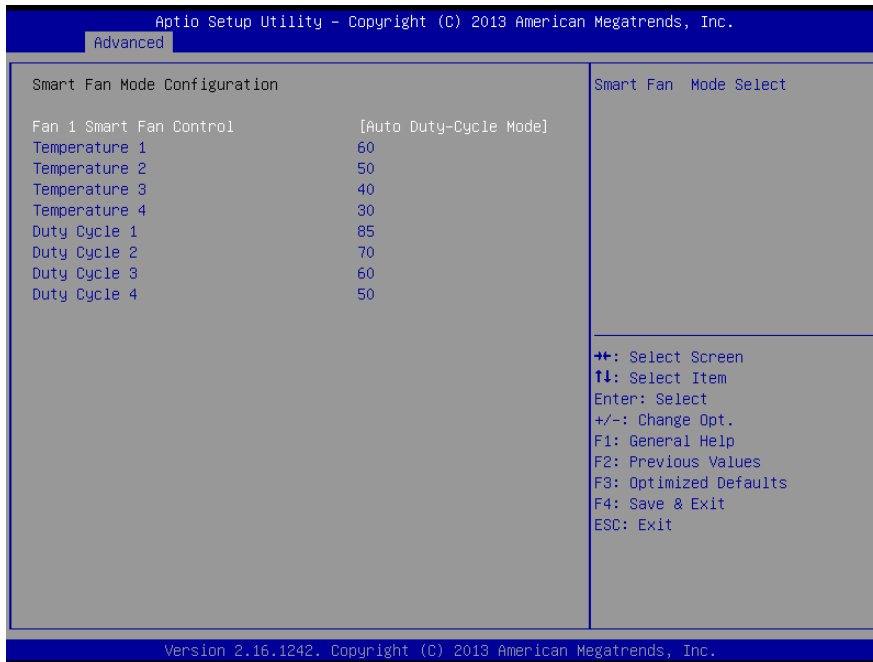

Options summary:

Fan 1 Smart Fan Control	Manual RPM Mode	
-------------------------	--------------------	--

	Manual Duty Mode	
	Auto RPM Mode	
	Auto Duty-Cycle Mode	Optimal Default, Failsafe Default
Smart Fan Mode Select		

### 3.4.3 Advanced: Digital IO



Options summary:

Pin 0~7	Input	Optimal Default, Failsafe Default
	Output	
Set DIO Port 0~7 as Input or Output		
Output Level	Low	Optimal Default, Failsafe Default
	Hi	
Set GPIO Level when used as Output		



### 3.4.4 Advanced: H/W Monitor

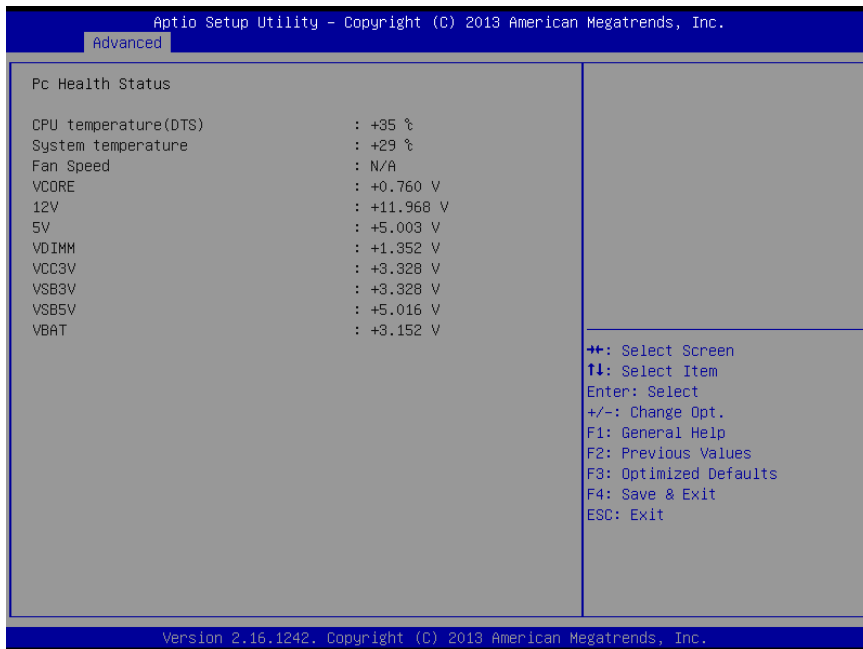

### 3.4.5 Advanced: CPU Configuration



Options summary:

Intel Virtualization	Disabled	Optimal Default, Failsafe Default
Technology	Enabled	
When enabled, a VMM can utilize the additional hardware capabilities provided by Vander pool Technology		

### 3.4.5.1 CPU Configuration: Socket 0 CPU Information

Aptio Setup Utility - Copyright (C) 2013 American Megatrends, Inc.

Main

Socket 0 CPU Information	
Intel(R) Atom(TM) CPU E3825 @ 1.33GHz	
CPU Signature	30679
Microcode Patch	901
Max CPU Speed	1330 MHz
Min CPU Speed	533 MHz
Processor Cores	2
Intel HT Technology	Not Supported
Intel VT-x Technology	Supported
L1 Data Cache	24 kB x 2
L1 Code Cache	32 kB x 2
L2 Cache	1024 kB x 1
L3 Cache	Not Present

++: Select Screen  
 ↑↓: Select Item  
 Enter: Select  
 +/-: Change Opt.  
 F1: General Help  
 F2: Previous Values  
 F3: Optimized Defaults  
 F4: Save & Exit  
 ESC: Exit

Version 2.16.1242. Copyright (C) 2013 American Megatrends, Inc.

### 3.4.6 Advanced: IDE Configuration

Aptio Setup Utility - Copyright (C) 2013 American Megatrends, Inc.

Advanced

IDE Configuration		Enable / Disable Serial ATA
Serial-ATA (SATA)	[Enabled]	
SATA Speed Support	[Gen2]	
SATA ODD Port	[No ODD]	
SATA Mode	[AHCI Mode]	
Serial-ATA Port 0	[Enabled]	
SATA Port0 HotPlug	[Disabled]	
Serial-ATA Port 1	[Enabled]	
SATA Port1 HotPlug	[Disabled]	
SATA Port0	Not Present	
SATA Port1	Not Present	

++: Select Screen  
 ↑↓: Select Item  
 Enter: Select  
 +/-: Change Opt.  
 F1: General Help  
 F2: Previous Values  
 F3: Optimized Defaults  
 F4: Save & Exit  
 ESC: Exit

Version 2.16.1242. Copyright (C) 2013 American Megatrends, Inc.

Options summary:

Serial-ATA(SATA)	Enabled	Default
	Disable	
SATA Speed Support	Gen1	
	Gen2	Default
SATA ODD Port	Port0 ODD	
	Port1 ODD	
	No ODD	Default
SATA Mode	IDE	
	AHCI	Default
IDE: Configure SATA controllers as legacy IDE		
AHCI: Configure SATA controllers to operate in AHCI mode		
Serial-ATA Port0/1	Enabled	Default
	Disable	
SATA Port0/1 HotPlug	Enabled	
	Disable	Default

### 3.4.7 Advanced: CSM Configuration

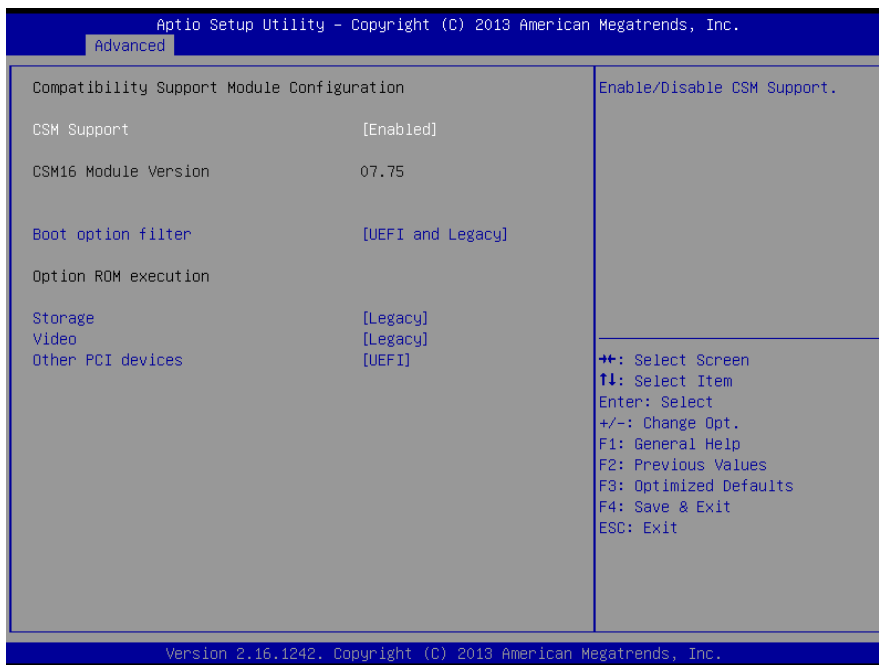

Options summary:

CSM Support	Disable	Default
	Enabled	
Boot option filter	UEFI and Legacy	Default
	Legacy only	
	UEFI only	
Storage & Video	Do not launch	Default
	UEFI	
	Legacy	
Other PCI devices	UEFI	Default
	Legacy	

### 3.4.8 Advanced: Trusted Computing

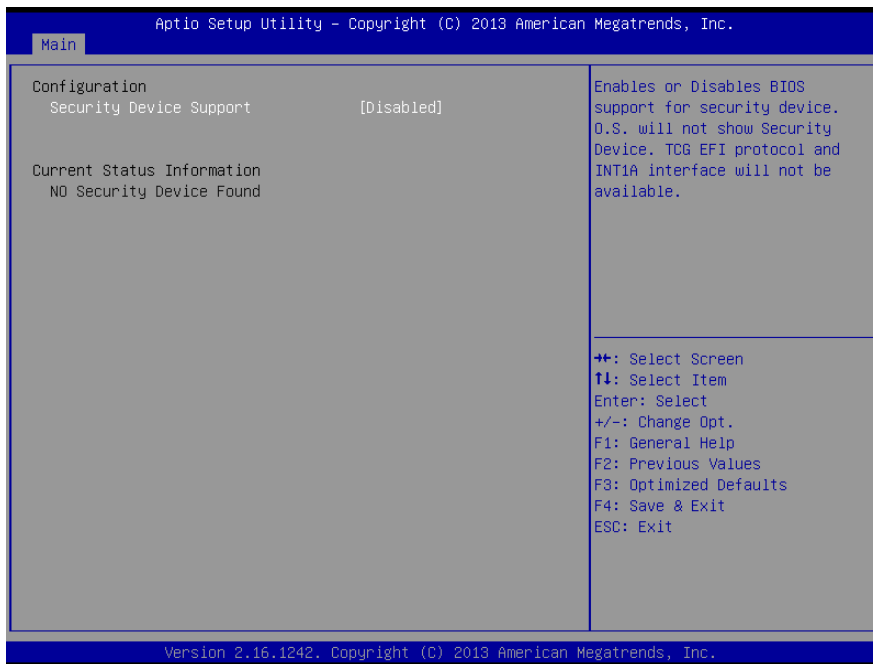

Options summary:

Security Device Support	Enabled	Optimal Default, Failsafe Default
	Disabled	
Enabled or Disabled BIOS Support for Security device. O.S. will not show Security Device. TCG EFI protocol and INT1A interface will not be available		

### 3.4.9 Advanced: USB Configuration

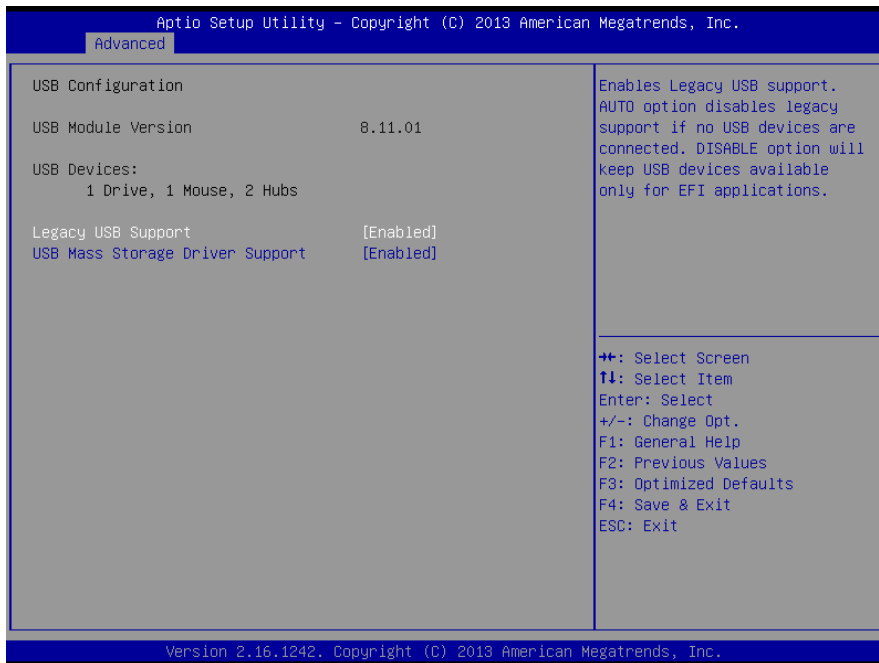

Options summary:

Legacy USB Support	Enabled	Optimal Default, Failsafe Default
	Disabled	
	Auto	
<p>Enables BIOS Support for Legacy USB Support. When enabled, USB can be functional in legacy environment like DOS.</p> <p>AUTO option disables legacy support if no USB devices are connected</p>		
USB Mass Storage Driver Support	Disabled	Optimal Default, Failsafe Default
	Enabled	
Enable/Disable USB Mass Storage Driver Support		
Device Name (Emulation Type)	Auto	Optimal Default, Failsafe Default
	Floppy	
	Forced FDD	
	Hard Disk	
	CDROM	
<p>If Auto. USB devices less than 530MB will be emulated as Floppy and remaining as Floppy and remaining as hard drive. Forced FDD option can be used to force a HDD formatted drive to boot as FDD(Ex. ZIP drive)</p>		

### 3.4.10 Advanced: Touch Device

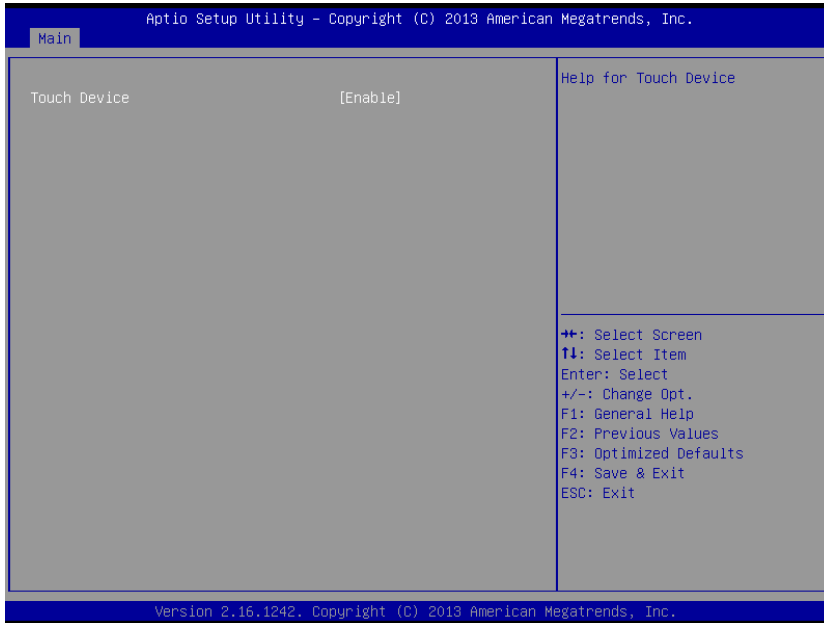

Options summary:

Touch Device	Disable	Default
	Enable	
Help for Touch Device		

### 3.5 Setup Submenu: Chipset

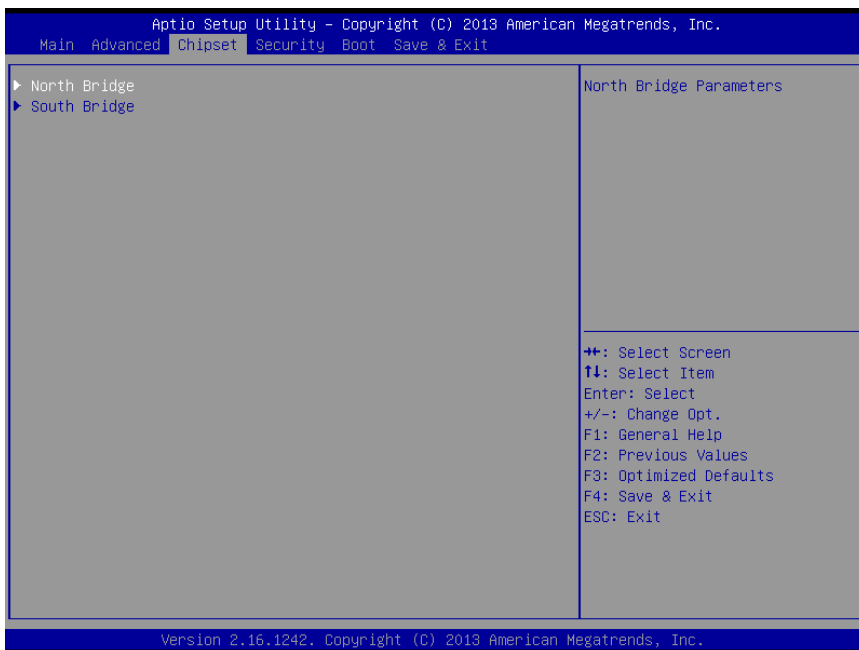

### 3.5.1 Chipset: Host Bridge

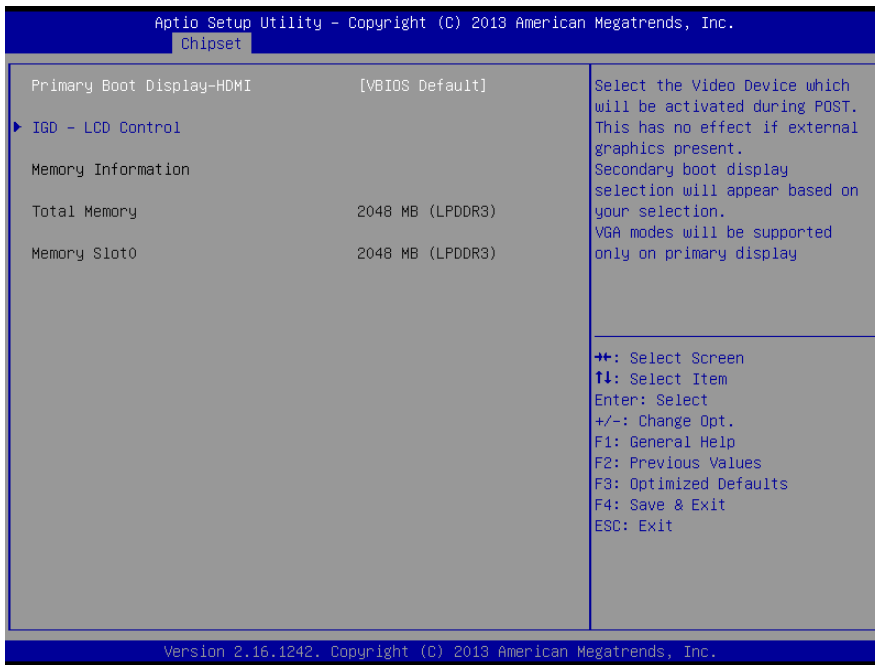

Options summary:

Primary Boot Display	VBIOS Default	Default
	CRT	
	DP/HDMI	
	LVDS	

### 3.5.1.1 CPU Configuration: Socket 0 CPU Information

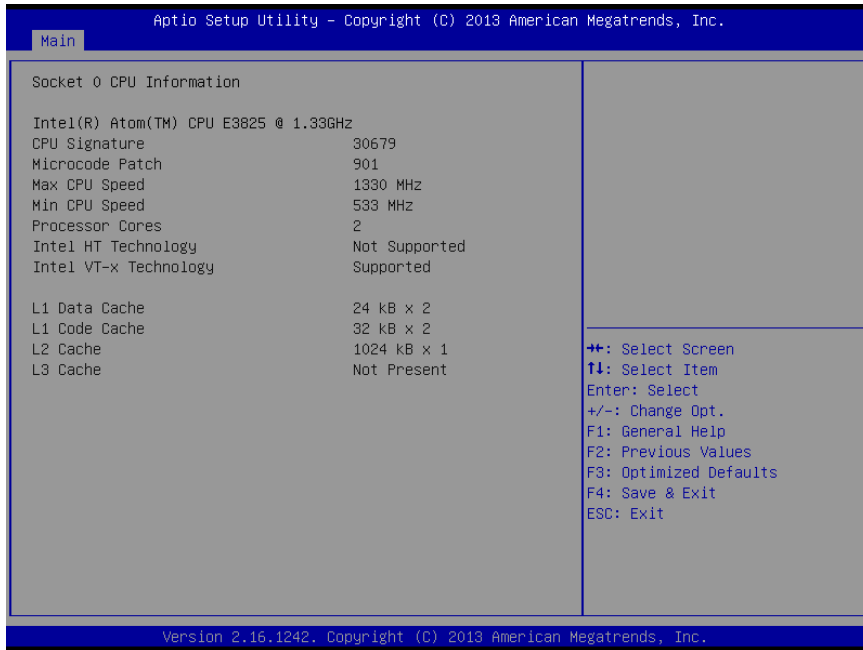

Options summary:

LVDS	Disabled	
	Enabled	Default
Enable or Disable LVDS interface		
Panel Type	640x480	Default
	800x480	
	800x600	
	1024x600	
	1024x768	
	1280x768	
	1280x1024	
	1366x768	
	1440x900	
	1600x1200	
	1920x1080	
	1920x1200	
Select panel resolution.		
Color Depth	18-Bit	Default
	24-Bit	
	36-Bit	
	48-Bit	



Select color depth of the panel		
Backlight Type	Normal	Default
	Inverted	
<p>Select Backlight control type.</p> <p>Inverted: Brightest for low PWM duty cycle and low voltage. Normal: Brightest for high PWM duty cycle and high voltage.</p>		
Backlight Level	0%	Default
	10%	
	20%	
	30%	
	40%	
	50%	
	60%	
	70%	
	80%	
	90%	
	100%	
Select Backlight Level		

### 3.5.2 Chipset: South Bridge

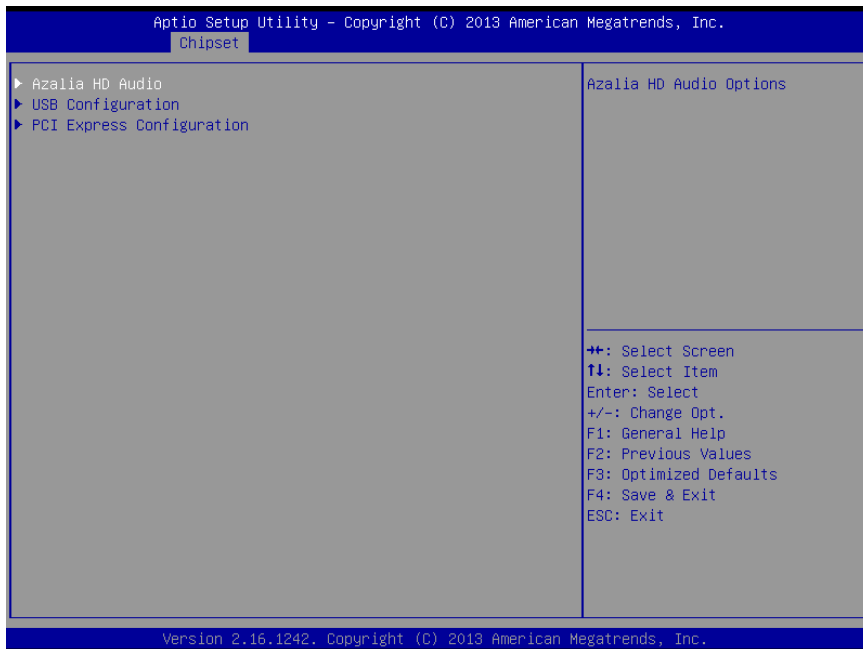

### 3.5.2.1 South Bridge: Azalia HD Audio

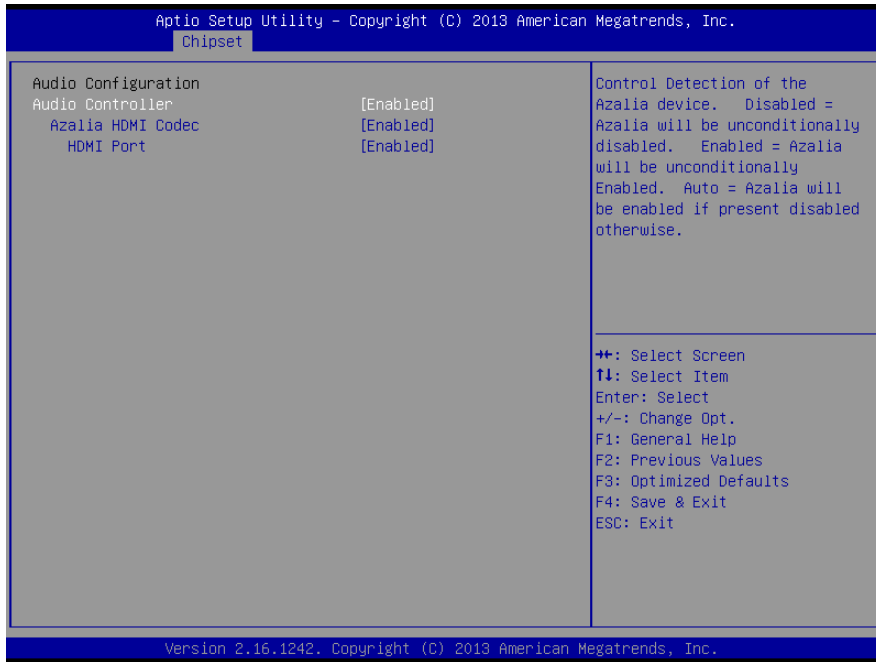

Options summary:

Audio Controller	Disabled	Default
	Enabled	
Control Detection of the Azalia device. Disabled = Azalia will be unconditionally disabled. Enabled = Azalia will be unconditionally Enabled. Auto = Azalia will be enabled if present disabled otherwise.		
Azalia HDMI codec	Disabled	Default
	Enabled	
Enable/Disable internal HDMI codec for Azalia		
HDMI Port	Disabled	Default
	Enabled	
Enable/Disable HDMI Port		

### 3.5.2.2 South Bridge: USB Configuration

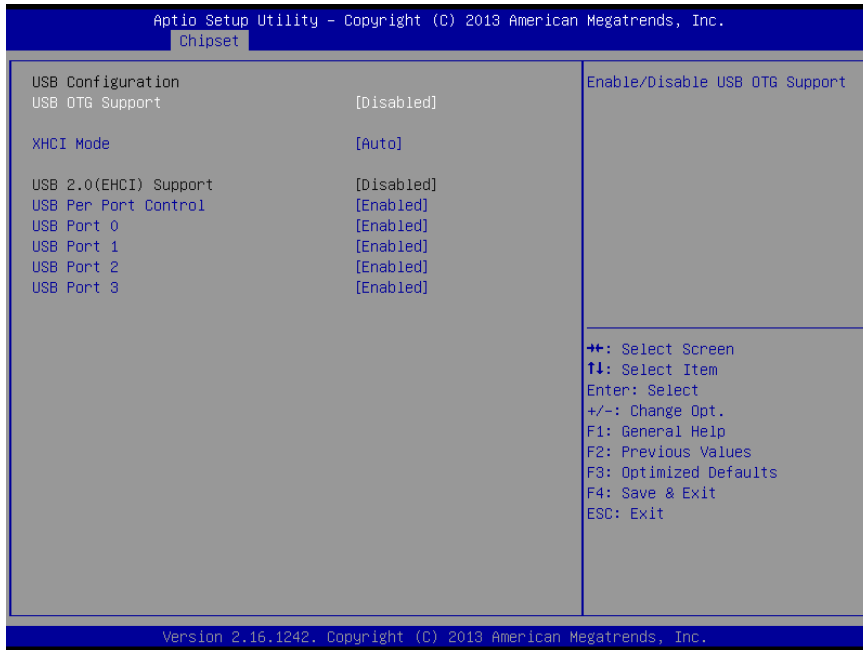

Options summary:

USB OTG Support	PCI mode	Default
	Disabled	
Enable/Disable USB OTG Support		
XHCI Mode	Enabled	Default
	Disabled	
	Auto	
	Smart Auto	
Mode of operation of XHCI controller		
USB Per Port Control	Enabled	Default
	Disabled	
Control each of the USB ports (0~3).		
Enable: Enable USB per port		
Disable: Use USB port X settings		
USB Port0/1/2/3	Enabled	Default
	Disabled	
Enable/Disable USB Port0/1/2/3		

### 3.5.2.3 South Bridge: PCI Express Configuration

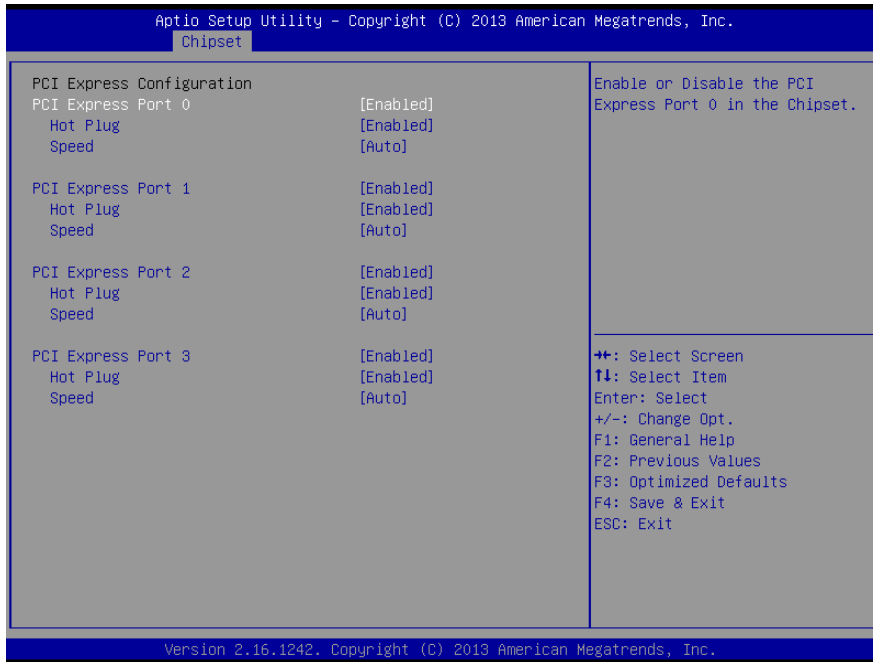

Options summary:

PCI Express Root Port 0/1/2/3	Enabled	Optimal Default, Failsafe Default
	Disabled	
Enabling/Disabling the PCI Express root ports		
Hot Plug	Disabled	Default
	Enabled	
Enabling/Disabling the PCI Express Hot Plug		
Speed	Auto	Default
	Gen2	
	Gen1	
Configure PCIe Port Speed		

### 3.6 Setup Submenu: Security



#### Change User/Administrator Password

You can set a User Password once an Administrator Password is set. The password will be required during boot up, or when the user enters the Setup utility. Please Note that a User Password does not provide access to many of the features in the Setup utility.

Select the password you wish to set, press Enter to open a dialog box to enter your password (you can enter no more than six letters or numbers). Press Enter to confirm your entry, after which you will be prompted to retype your password for a final confirmation. Press Enter again after you have retyped it correctly.

#### Removing the Password

Highlight this item and type in the current password. At the next dialog box press Enter to disable password protection.

### 3.7 Setup Submenu: Boot

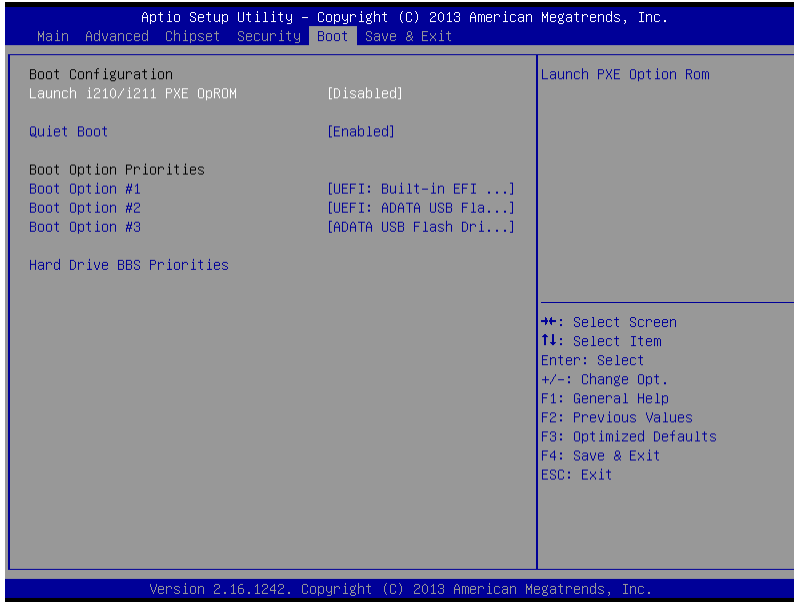

Options summary:

Launch i210/i211 PXE OpROM	Disabled	Default
	Enabled	
Launch PXE Option Rom		
Quiet Boot	Disabled	Default
	Enabled	
En/Disables Quiet Boot option		

### 3.8 Setup submenu: Exit

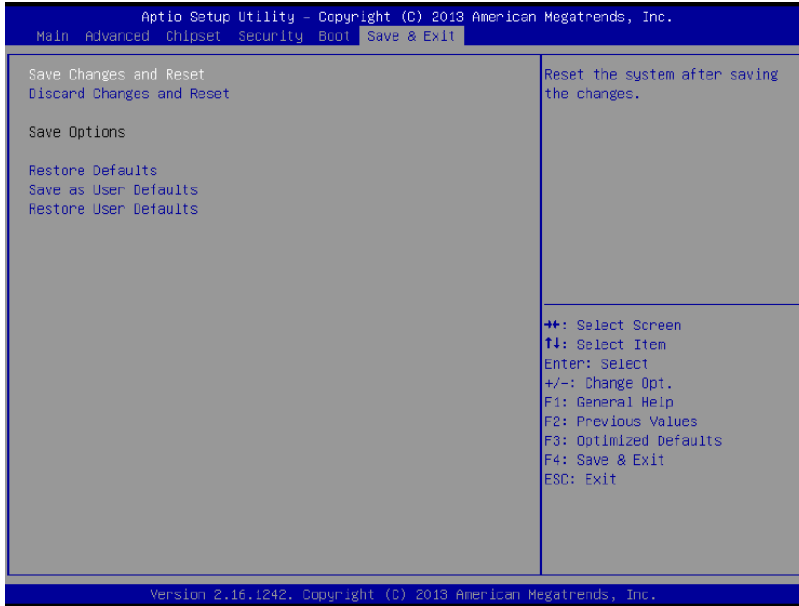

# Chapter 6

## 4. Specification

Model	eIVP1300									
System	Processor	Intel® Atom™ E3845 / E3825 Processor (Default: E3845)								
	Main Memory	Onboard DDR3L 1066 / 1333 /1600 (Default: 1600MHz 4GB)								
Video	Format	H.265 / H.264								
	Video Input	IP camera x 4								
	Video Output	HDMI x 1, VGA x 1								
Audio	Audio Input	Mic-in x 1								
	Audio Output	Line-out x 1								
Recording	Format	H.265 / H.264								
	Resolution	1920 x 1080 at 30fps (NTSC) / 25fps (PAL)								
Storage	Internal mSATA	mSATA (half size) x 1 (optional)								
	Removable SSD	2.5" SSD x 1 (optional)								
	RAID	N/A								
Network	Ethernet	Intel®I211 (or 210) 10/100/1000 based; GbE port x 2								
	Wi-Fi	Optional								
	3G / 4G	Optional								
	GPS / G-Sensor	Optional								
Alarm	Digital I/O	Supports 8-bit digital I/O (optional)								
Interface	Front I/O Panel	Power button x 1; Reset button x 1; USB2.0 x 2								
	Rear I/O Panel	<table border="0"> <tr> <td>Remote power x 1</td> <td>Mic-in x 1</td> </tr> <tr> <td>3G/4G/WIFI LED x 3</td> <td>GbE port (RJ-45) x 2</td> </tr> <tr> <td>USB3.0 x 1; USB2.0 x 1</td> <td>VGA x 1; HDMI x 1</td> </tr> <tr> <td>Audio line-out x 1</td> <td>RS-232 x 2</td> </tr> </table>	Remote power x 1	Mic-in x 1	3G/4G/WIFI LED x 3	GbE port (RJ-45) x 2	USB3.0 x 1; USB2.0 x 1	VGA x 1; HDMI x 1	Audio line-out x 1	RS-232 x 2
	Remote power x 1	Mic-in x 1								
3G/4G/WIFI LED x 3	GbE port (RJ-45) x 2									
USB3.0 x 1; USB2.0 x 1	VGA x 1; HDMI x 1									
Audio line-out x 1	RS-232 x 2									
Expansion Slot	Mini-Card slot x 1 (full-size)									
General	Power Supply	DC 9-24V, with ignition pin								
	Dimensions (W x D X H)	7" x 7.34" x 2" / 177.8mm x 186.5mm x 50.4mm (without bracket)								
	Gross Weight	5.7lb (2.6kg)								
	Operating	-32°F ~ 140°F (0°C ~ 60°C); Project base: -40°C ~ 85°C								
	Storage	-40°F ~ 176°F (-40°C ~ 80°C)								
	Storage Humidity	0%~90% @40°C, non-condensing								
	Vibration/Shock	MIL-STD-810G								
	Certification	CE & FCC Class A, RoHS								

Note: All specifications are subject to change without notice.



# EverFocus Electronics Corp.

## EverFocus Taiwan:

2F., No.12, Ln. 270, Sec. 3, Beishen Rd., Shenkeng Dist., New Taipei City 222, Taiwan

TEL: +886 2 2662 2338

FAX: +886 2 2662 3632

[www.everfocus.com.tw](http://www.everfocus.com.tw)

[marketing@everfocus.com.tw](mailto:marketing@everfocus.com.tw)

## EverFocus USA - California:

1801 Highland Avenue, Unit A, Duarte, CA 91010, USA

TEL: +1 626 844 8888

FAX: +1 626 844 8838

[www.everfocus.com](http://www.everfocus.com)

[sales@everfocus.com](mailto:sales@everfocus.com)

## EverFocus China - Shenzhen:

3F, Building 7, Longcheng Industrial Park, No.39, Longguan No.7 Road, Dalang Street, Longhua, Shenzhen, Guangdong, China

TEL: +86 755 2765 1313

FAX: +86 755 2765 0337

[www.everfocus.com.cn](http://www.everfocus.com.cn)

[marketing@everfocus.com.cn](mailto:marketing@everfocus.com.cn)

## EverFocus Japan:

3F, Kuramochi, Building II, 2-2-3 Koto-Bashi, Sumida-Ku, Tokyo, 130-0022, Japan

TEL: +81 3 5625 8188

FAX: +81 3 5625 8189

[www.everfocus.co.jp](http://www.everfocus.co.jp)

[info@everfocus.co.jp](mailto:info@everfocus.co.jp)

	<p>Your EverFocus product is designed and manufactured with high quality materials and components which can be recycled and reused.</p> <p>This symbol means that electrical and electronic equipment, at their end-of-life, should be disposed of separately from your household waste.</p> <p>Please, dispose of this equipment at your local community waste collection/recycling centre.</p> <p>In the European Union there are separate collection systems for used electrical and electronic product.</p> <p>Please, help us to conserve the environment we live in!</p>	<p>Ihr EverFocus Produkt wurde entwickelt und hergestellt mit qualitativ hochwertigen Materialien und Komponenten, die recycelt und wieder verwendet werden können.</p> <p>Dieses Symbol bedeutet, dass elektrische und elektronische Geräte am Ende ihrer Nutzungsdauer vom Hausmüll getrennt entsorgt werden sollen.</p> <p>Bitte entsorgen Sie dieses Gerät bei Ihrer örtlichen kommunalen Sammelstelle oder im Recycling Centre.</p> <p>Helfen Sie uns bitte, die Umwelt zu erhalten, in der wir leben!</p>
---	--	---



**EverFocus**

P/N: 4605EIVP103001A